

Datasheet

产品名称 (Product): BLE module

产品型号 (Model No.): YJ-16060-nRF51822

目录

1. Description.....	3
2. Introduction.....	4
2.1 Programmer.....	5
2.2 Software development Tool.....	5
2.3 Protocols.....	5
Software Development Kit.....	5
2.4 SoftDevices.....	5
3. Product Descriptions.....	6
3.1 Mechanical drawings.....	6
3.2 Pin assignments.....	7
4. Miscellaneous.....	8
5. Absolute maximum ratings.....	8
6. List of Holyiot module.....	10

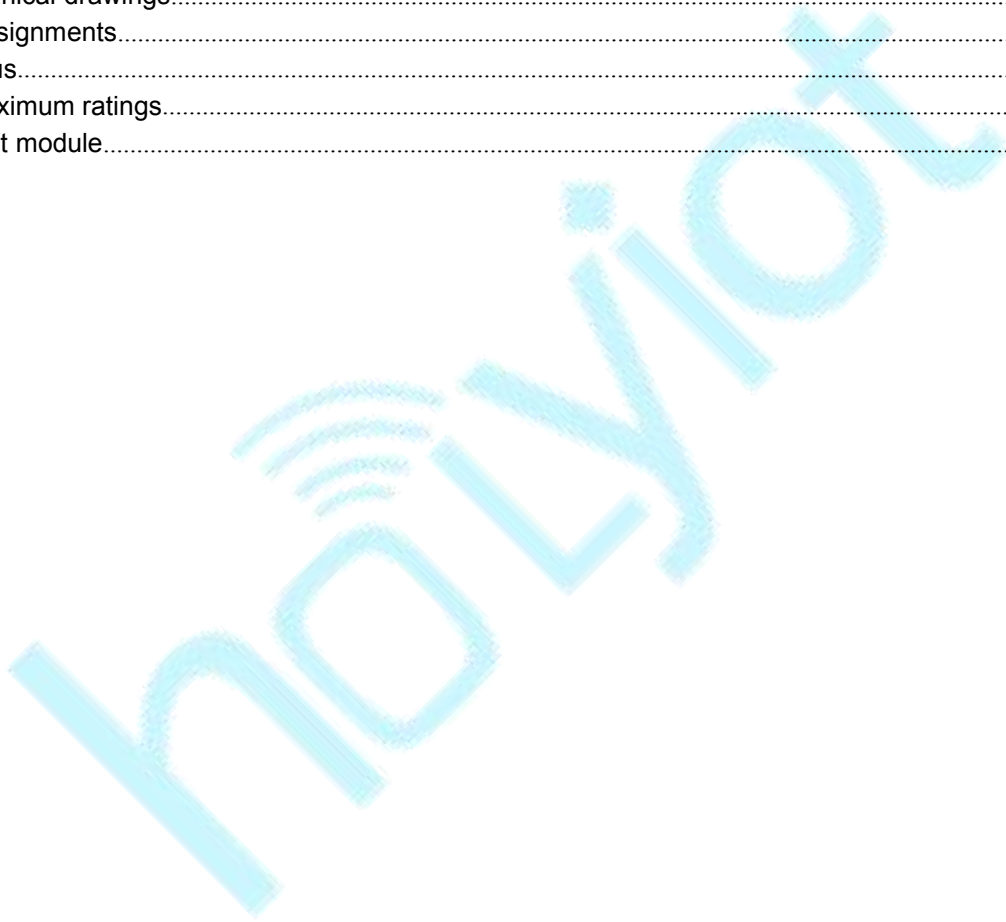

1. Description

YJ-16060 BLE module use nRF51822 QFAA chip. It can broadcast data. YJ-16060-nRF51822 module is a powerful, highly flexible multiprotocol SoC ideally suited for Bluetooth® low energy and 2.4GHz ultra low-power wireless applications. The nRF51822 is built around a 32-bit ARM® Cortex™ M0 CPU with 256kB flash + 16kB RAM for improved application performance. The embedded 2.4GHz transceiver supports both Bluetooth low energy and the Nordic Gazell 2.4 GHz protocol stack which is on air compatible with the nRF24L series products from Nordic Semiconductor.

nRF51822 QFAA chip

SWD programmer(SWDIO,SWCLK,VDD,GND)

CR2032 battery holder

LPS22HB

Features :

Single chip, highly flexible, 2.4 GHz multi-protocol device

32-bit ARM Cortex M0 CPU core

256kB flash + 16kB RAM

Supports Bluetooth low energy protocol stacks

Thread safe and run-time protected

Event driven API

On air compatible with nRF24L series

3 data rates (2Mbps/1Mbps/250kbps)

+4dBm output power

-93dBm sensitivity, Bluetooth low energy

PPI system for maximum power-efficient applications and code simplification

Flexible power management system with automatic power management of each peripheral

Configurable I/O mapping for analog and digital I/O

Operating temperature range: -40°C to +105°C

Application:

- Mobile phone accessories
- Wearables
- Beacons
- Rezence wireless charging monitoring
- PC peripherals
- Consumer Electronics (CE) remote controls
- Proximity/Alert sensors
- Smart Home
- Sports, fitness and healthcare sensors
- Smart RF tags
- Toys and electronic games
- Intelligent domestic appliances
- Industrial and commercial sensors
- Lighting

2. Introduction

YJ-16060 BLE module use nRF51822 QFAA chip. It can broadcast data. YJ-16060-nRF51822 module is a powerful, highly flexible multiprotocol SoC ideally suited for Bluetooth® low energy and 2.4GHz ultra low-power wireless applications. The nRF51822 is built around a 32-bit ARM® Cortex™ M0 CPU with 256kB flash + 16kB RAM for improved application performance. The embedded 2.4GHz transceiver supports both Bluetooth low energy and the Nordic Gazell 2.4 GHz protocol stack which is on air compatible with the nRF24L series products from Nordic Semiconductor.

nRF51822 QFAA chip

SWD programmer(SWDIO,SWCLK,VDD,GND)

CR2032 battery holder

LPS22HB

2.1 Programmer

YJ-16060 BLE module use the Serial Wire Debug(SWD port), the module which layout the SWDIO, SWCLK, VDD, GND for debug and flash your own firmware, more info about the SWD, please visit https://www.silabs.com/community/mcu/32-bit/knowledge-base.entry.html/2014/10/21/serial_wire_debugs-qKCT

You can using the Jlink or Jtag for programmer.

2.2 Software development Tool

It supports the standard Nordic Software Development Tool-chain using Segger Embedded Studio, Keil, IAR and GCC. More info please visit

https://www.nordicsemi.com/DocLib/Content/User_Guides/getting_started/latest/UG/common/nordic_tools

2.3 Protocols

Software Development Kit

Nordic Semiconductor's Software Development Kits (SDK) are your starting point for software development on the nRF51 and nRF52 Series. It contains source code libraries and example applications covering wireless functions, libraries for all peripherals, bootloaders, wired and OTA FW upgrades, RTOS examples, serialization libraries.

More info please visit

https://www.nordicsemi.com/DocLib/Content/User_Guides/getting_started/latest/UG/gs/development_sw

You can also download the SDK for coding development .

2.4 SoftDevices

Nordic Semiconductor protocol stacks are known as SoftDevices. SoftDevices are pre-compiled, pre-linked binary files. SoftDevices can be programmed in nRF5 series devices, and are freely downloadable from the Nordic website.

Please download that here: <https://www.nordicsemi.com/Software-and-Tools/Software/S130>

Over-The-Air DFU

The SoC is supported by an Over-The-Air Device Firmware Upgrade (OTA DFU) feature. This allows for in the field updates of application software and SoftDevice.

3. Product Descriptions

3.1 Mechanical drawings

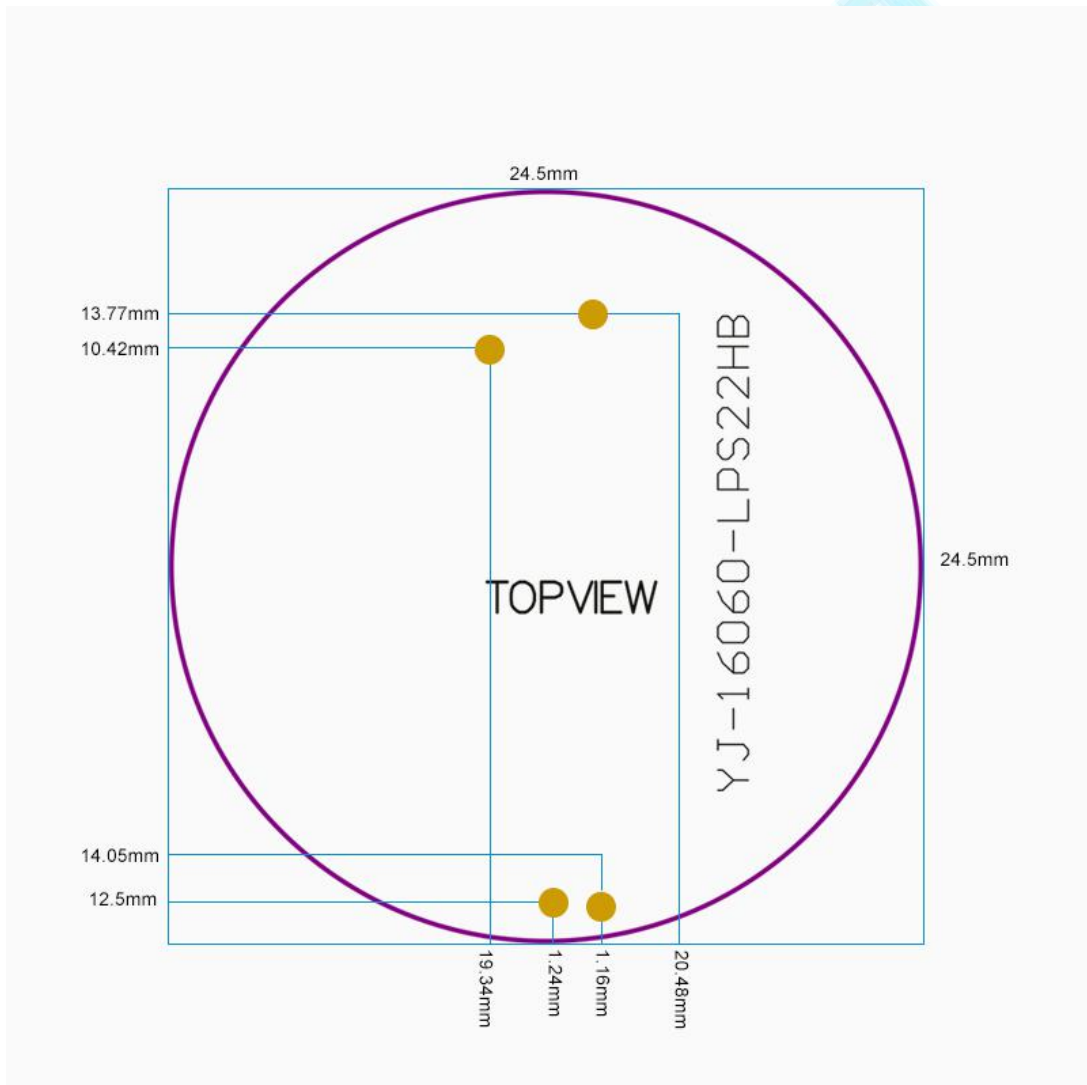

3.2 Pin assignments

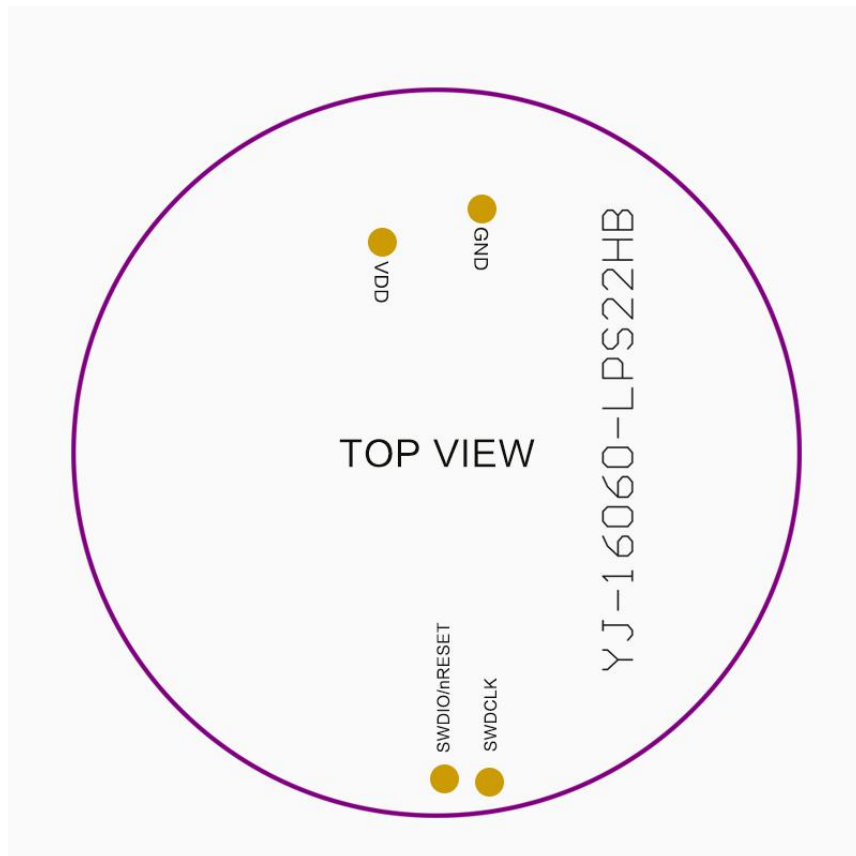

PIN No.	PIN define	Functions
1	VDD	Power
2	SWDIO	System reset (active low). Hardware debug and flash programming I/O.
3	SWCLK	Hardware debug and flash programming I/O.
4	GND	Ground

4. Miscellaneous

Soldering Temperature-Time Profile for Re-Flow Soldering. Maximum number of cycles for re-flow is 2. No opposite side re-flow is allowed due to module weight.

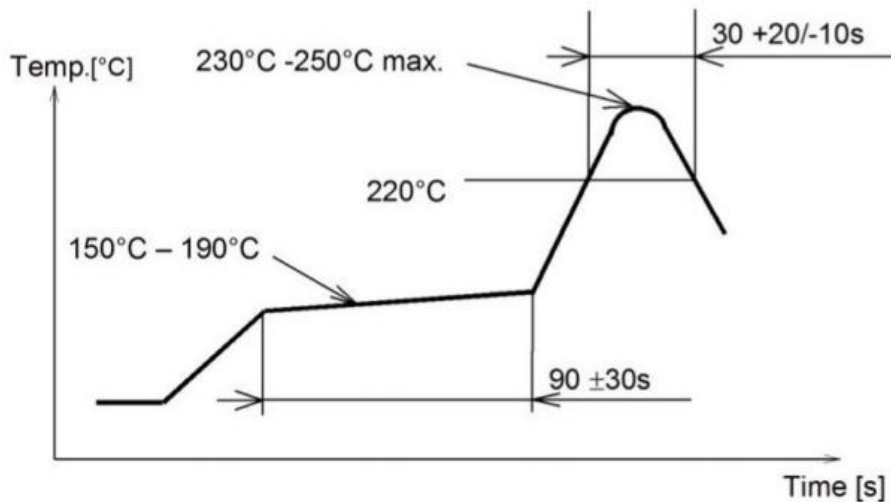

5. Absolute maximum ratings

Maximum ratings are the extreme limits to which the chip can be exposed for a limited amount of time without permanently damaging it. Exposure to absolute maximum ratings for prolonged periods of time may affect the reliability of the device.

Absolute maximum ratings:











Symbol	Parameter	Min.	Max.	Unit
Supply voltages				
VDD		-0.3	+3.9	V
DEC2			2	V
VSS			0	V
I/O pin voltage				
VIO		-0.3	VDD + 0.3	V
Environmental QFN48 package				
Storage temperature		-40	+125	°C
MSL	Moisture Sensitivity Level		2	
ESD HBM	Human Body Model		4	kV
ESD CDM	Charged Device Model		750	V
Environmental WLCSP package				
Storage temperature		-40	+125	°C
MSL	Moisture Sensitivity Level		1	
ESD HBM	Human Body Model		4	kV
ESD CDM	Charged Device Model		500	V
Flash memory				
Endurance		20 000 ¹		write/erase cycles
Retention		10 years at 40 °C 50 years at 25 °C		
Number of times an address can be written between erase cycles			2	times

1. Flash endurance is 20,000 erase cycles. The smallest element of flash that can be written is a 32 bit word.



6. List of Holyiot module



Part No.	Nordic chip	Holyiot No.	PA	Antenna	Picture
1	nRF51822	Holyiot-17085-PA	✓	IPX antenna	 
2	nRF51822	YJ-15011-nRF51822	×	PCB antenna	 
3	nRF51822	YJ-14015-nRF51822	×	PCB antenna	 
4	nRF52832	YJ-16048-nRF52832	×	PCB antenna	 
5	nRF52832	YJ-17029-nRF52832	✓	Ceramic antenna	 

6	nRF52832	YJ-16002-nRF52832	×	PCB antenna	 
7	nRF52832	YJ-17024-nRF52832	✓	IPX antenna	 
8	nRF52832	YJ-17095-nRF52832	×	Ceramic antenna	 
9	nRF52832	YJ-17017-USB	×	Ceramic antenna	 
10	nRF52832	YJ-17076-USB	×	PCB antenna	 
11	nRF52840	YJ-17120-USB	×	PCB antenna	 
12	nRF52840	YJ-18010-nRF52840	×	Ceramic antenna	 
13	nRF52840	YJ-18039-nRF52840	×	IPX antenna & PCB antenna	 