

# Datasheet

产品名称 (Product): BT 5.0 module (nRF52840)

产品型号 (Model No.): Holyiot-22043-NRF52840

目录

1. Overview.....	3
1.1. Application.....	3
1.2. Specifications.....	4
2. Introduction.....	5
2.1 Programmer.....	5
2.2 Software development Tool.....	5
2.3 Protocols.....	5
Software Development Kit.....	5
2.4 SoftDevices.....	6
3. Product Descriptions.....	6
3.1 Mechanical drawings.....	6
3.2 Pin assignments.....	7
4. Mounting our board on the host PCBA.....	9
5. Miscellaneous.....	10
6. Absolute maximum ratings.....	10
7. List of Holyiot module.....	11

# 1. Overview

Holyiot-22043 is powerful, highly flexible ultra-low power Bluetooth low energy (BLE) module using Nordic NRF52840 SoC, with ARM Cortex-M4 CPU, which has floating Point unit (FPU), 1MB flash with cache and 256kB RAM. It offers a wealth of peripherals that include NFC, USB and multiple interface options including Quad SPI (QSPI).

It has high-end security features included to achieve best in class security with an ARM CryptoCell cryptographic system on chip and a full AES 128-bit encryption suite, it supports BLE mesh

Bluetooth 5.0 long range

Processing power and flash flexibility

Multiprotocol radio

Power Efficiency

Model	Holyiot-22043
Chip	nRF52840 QIAACO
Size	18mm(L)*13.50mm(W)*0.8mm(H)
BLE Antenna	Ceramic Antenna
BT Range	500 meters for bluetooth 5.0
FCC ID	/

## 1.1. Application

- Internet of Things (IoT)
- SmartHome sensors
- Computer peripherals
- A4WP 'Rezence' wireless charging
- Sports and fitness sensors and hubs
- Smart watches
- Interactive games
- Wearables
- Connected white goods
- Voice-command smart remotes
- Beacons
- Connected health products
- RC Toys
- Building automation and sensor networks

## 1.2. Specifications

- Bluetooth 5 ready multi-protocol radio
  - 2Mbps
  - Long range
  - Advertising extensions
  - Improved coexistence (CSA #2)
- IEEE 802.15.4 radio support
  - Thread
  - Zigbee
- 32-bit ARM Cortex-M4F @ 64MHz
- Up to 111 dB link budget for Bluetooth long range mode
- Full-speed 12Mbps USB controller
- NFC Tag-A
- Software stacks available as downloads
- Programmable output power from +8dBm to -20dBm
- On-air compatible with nRF51, nRF24L and nRF24AP
- Series
- High-precision RSSI
- 128 bit AES/ECB/CCM/AAR co-processor
- Single-ended antenna output (on-chip balun)
- Software stacks available as downloads
- Application development independent of protocol stack
- Wide supply voltage range + 1.7V to 5.5V
- QSPI/SPI/2-wire/I<sup>2</sup>S/PDM/QDEC
- Programmable Peripheral Interface - PPI
- High speed SPI interface 32MHz
- Quad SPI interface 32MHz
- EasyDMA for all digital interfaces
- RAM mapped FIFO using EasyDMA
- 12bit/200K SPS ADC
- On-chip DC-DC buck converter
- Quadrature demodulator
- -96dBm Sensitivity for Bluetooth low energy
- Arm CryptoCell CC310 cryptographic security module
- QSPI/SPI/2-wire/I<sup>2</sup>S/PDM/QDEC

## 2. Introduction

Holyiot-22043 is powerful, highly flexible ultra-low power Bluetooth low energy (BLE) module using Nordic NRF52840 SoC, with ARM Cortex-M4 CPU, which has floating Point unit (FPU), 1MB flash with cache and 256kB RAM. It offers a wealth of peripherals that include NFC, USB and multiple interface options including Quad SPI (QSPI).

It has high-end security features included to achieve best in class security with an ARM CryptoCell cryptographic system on chip and a full AES 128-bit encryption suite

## 2.1 Programmer

Holyiot-22043 module use the Serial Wire Debug(SWD port ), the module which layout the SWDIO, SWCLK, VDD, GND for debug and flash your own firmware, more info about the SWD, please visit [https://www.silabs.com/community/mcu/32-bit/knowledge-base.entry.html/2014/10/21/serial\\_wire\\_debugs-qKCT](https://www.silabs.com/community/mcu/32-bit/knowledge-base.entry.html/2014/10/21/serial_wire_debugs-qKCT)

You can using the Jlink or Jtag for programmer.

## 2.2 Software development Tool

It supports the standard Nordic Software Development Tool-chain using Segger Embedded Studio, Keil, IAR and GCC. More info please visit

[http://infocenter.nordicsemi.com/index.jsp?topic=/com.nordic.infocenter.nrf52/dita/nrf52/development/nrf52\\_dev\\_kit.html&cp=1\\_1](http://infocenter.nordicsemi.com/index.jsp?topic=/com.nordic.infocenter.nrf52/dita/nrf52/development/nrf52_dev_kit.html&cp=1_1)

## 2.3 Protocols

This module support Bluetooth 5, Bluetooth Low Energy,Bluetooth mesh,Thread,802.15.4,ANT, 2.4GHz proprietary. So we can use different protocols for different situations.

### **Software Development Kit**

Nordic Semiconductor's Software Development Kits (SDK) are your starting point for software development on the nRF51 and nRF52 Series. It contains source code libraries and example applications covering wireless functions, libraries for all peripherals, bootloaders, wired and OTA FW upgrades, RTOS examples, serialization libraries.

More info please visit <http://www.nordicsemi.com/eng/Products/nRF52840-DK>

You can also download the SDK for coding development .

## 2.4 SoftDevices

Nordic Semiconductor protocol stacks are known as SoftDevices. SoftDevices are pre-compiled, pre-linked binary files. SoftDevices can be programmed in nRF5 series devices, and are freely downloadable from the Nordic website. Please download that here:

[http://www.nordicsemi.com/eng/nordic/download\\_resource/60625/19/19221576/116072](http://www.nordicsemi.com/eng/nordic/download_resource/60625/19/19221576/116072)

### Over-The-Air DFU

The SoC is supported by an Over-The-Air Device Firmware Upgrade (OTA DFU) feature. This allows for in the field updates of application software and SoftDevice.

## 3. Product Descriptions

### 3.1 Mechanical drawings

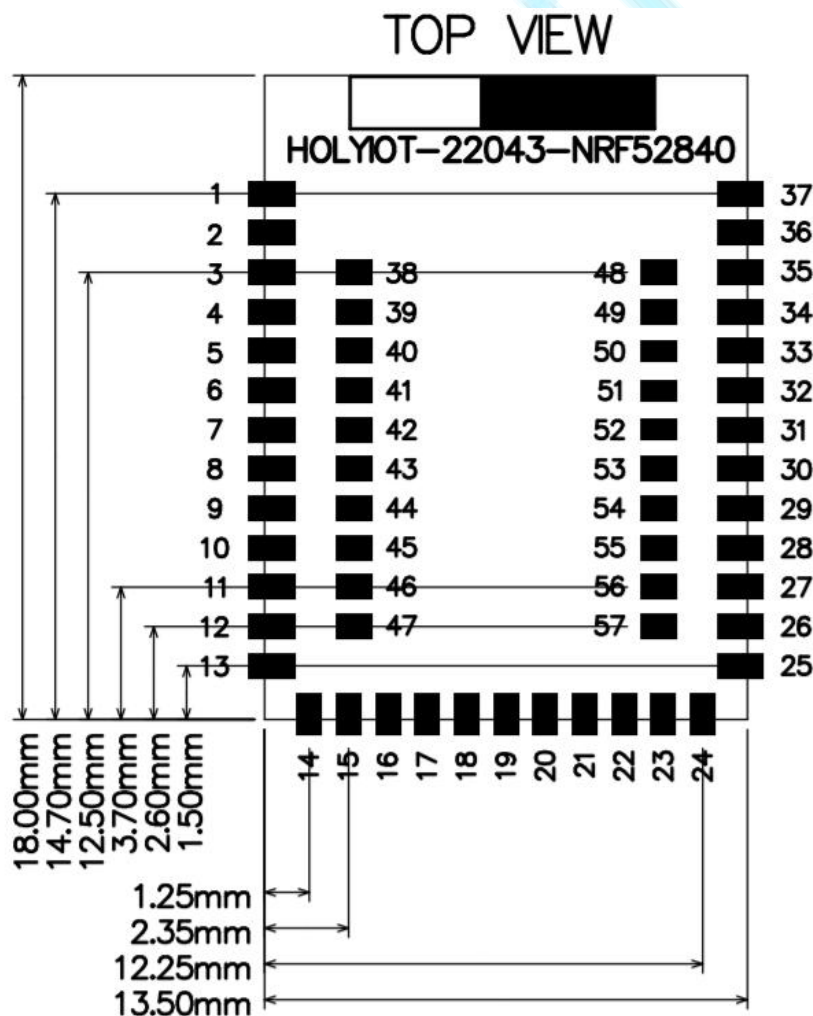



10	P0.30 AIN6	General purpose I/O Analog input
11	P0.31 AIN7	General purpose I/O Analog input
12	P0.04 AIN2	General purpose I/O Analog input
13	P0.05 AIN3	General purpose I/O Analog input
14	VDD	Power supply
15	P0.07 TRACECLK	General purpose I/O Trace buffer clock
16	P1.09 TRACEDATA3	General purpose I/O Trace buffer TRACEDATA[3]
17	P0.12 TRACEDATA1	General purpose I/O Trace buffer TRACEDATA[1]
18	P0.23	General purpose I/O
19	P0.21	General purpose I/O
20	P0.19	General purpose I/O
21	P0.18 nRESET	General purpose I/O Configurable as pin RESET
22	VBUS	5 V input for USB 3.3 V regulator
23	D-	USB D-
24	D+	USB D+
25	GND	Ground
26	P0.22	General purpose I/O
27	P1.00 TRACEDATA0	General purpose I/O Trace buffer TRACEDATA[0] Serial wire output (SWO)
28	P1.03	General purpose I/O
29	P1.01	General purpose I/O
30	P1.02	General purpose I/O
31	SWDCLK	SWD clock input for debug and programming
32	SWDIO	SWD I/O for debug and programming
33	P1.04	General purpose I/O
34	P1.06	General purpose I/O
35	P0.09	General purpose I/O



	NFC1	NFC antenna connection
36	P0.10 NFC2	General purpose I/O NFC antenna connection
37	GND	Ground
38	P1.14	General purpose I/O
39	P1.12	General purpose I/O
40	P0.25	General purpose I/O
41	P0.11 TRACEDATA2	General purpose I/O Trace buffer TRACEDATA[2]
42	P1.08	General purpose I/O
43	P0.27	General purpose I/O
44	P0.08	General purpose I/O
45	P0.06	General purpose I/O
46	P0.26	General purpose I/O
47	VDDH	High voltage power supply
48	P1.07	General purpose I/O
49	P1.05	General purpose I/O
50	P0.24	General purpose I/O
51	P0.20	General purpose I/O
52	P0.17	General purpose I/O
53	P0.15	General purpose I/O
54	P0.14	General purpose I/O
55	P0.13	General purpose I/O
56	P0.16	General purpose I/O
57	DCCH	DC/DC converter output

## 4. Mounting our board on the host PCBA

We suggest that you mount our RF board(Holyiot-18010-nRF52840) on the board like that:

- 1.
2. For the best Bluetooth performance, the antenna of the area need to extend about several mm without ground under the antenna of the edge of the host PCB.
3. The second choice is that place our board at the corner of host PCB, the antenna of board need to extend several mm outside of the Ground plane of the host PCB.

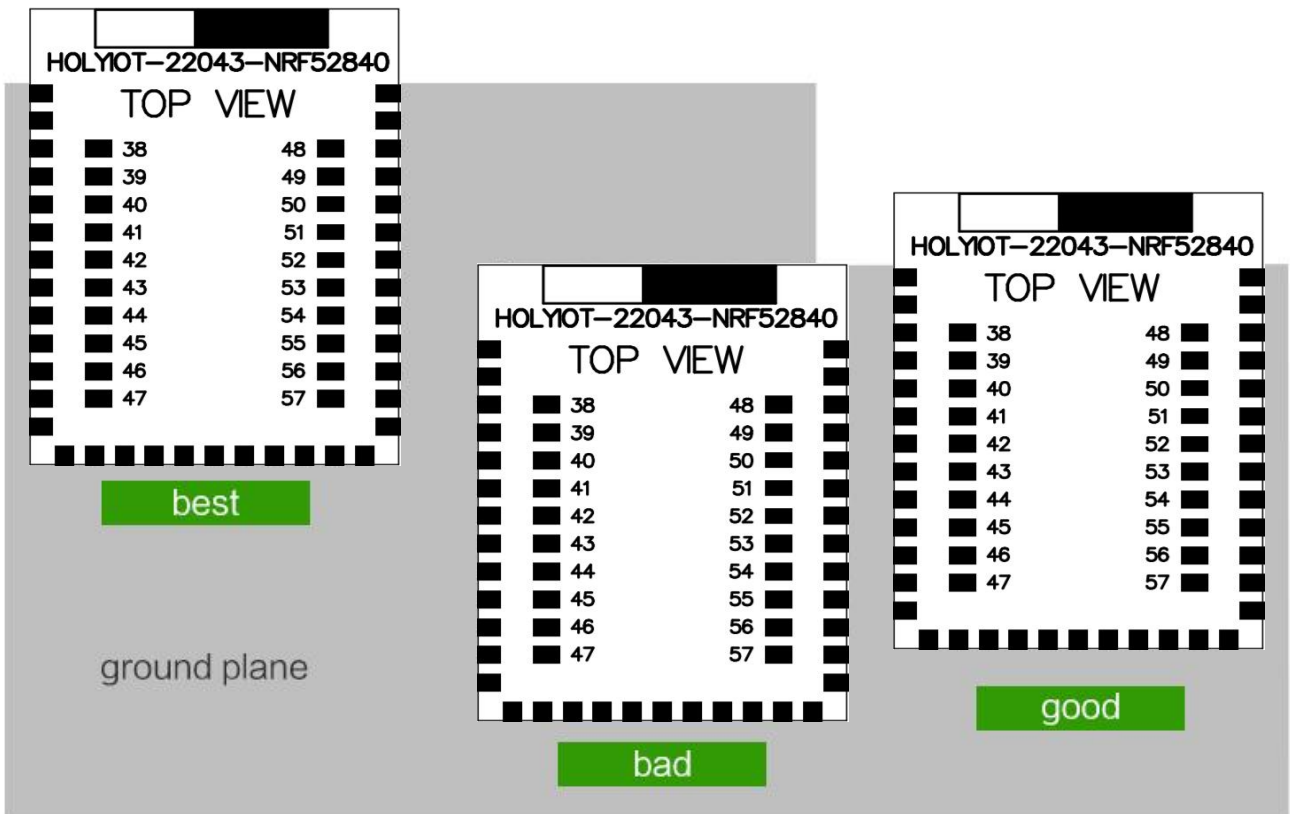

## 5. Miscellaneous

Soldering Temperature-Time Profile for Re-Flow Soldering. Maximum number of cycles for re-flow is 2. No opposite side re-flow is allowed due to module weight.

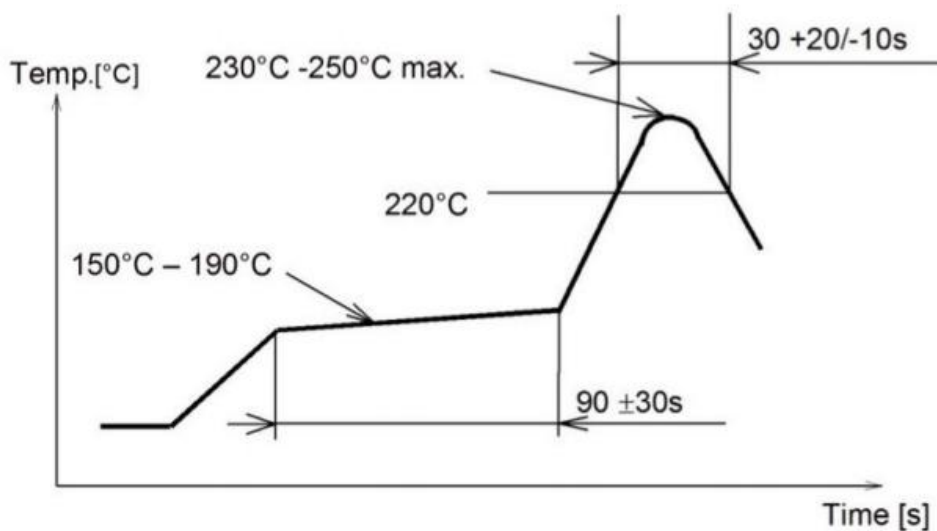

## 6. Absolute maximum ratings

Maximum ratings are the extreme limits to which the chip can be exposed for a limited amount of time without permanently damaging it. Exposure to absolute maximum ratings for prolonged periods of time may affect the reliability of the device.









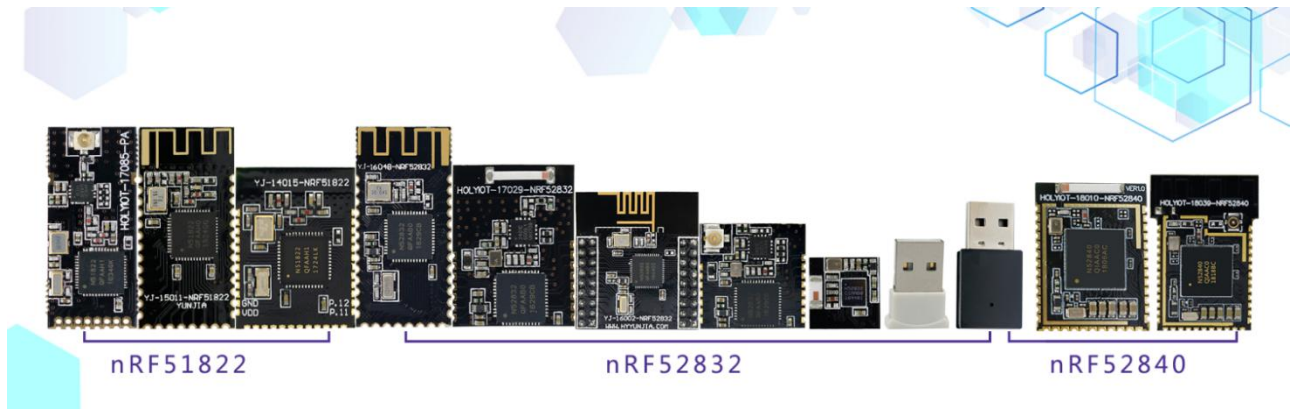

Absolute maximum ratings:

	Note	Min.	Max.	Unit
<b>Supply voltages</b>				
VDD		-0.3	+3.9	V
VDDH		-0.3	+5.8	V
VBUS		-0.3	+5.8	V
VSS			0	V
<b>I/O pin voltage</b>				
V <sub>I/O</sub> , VDD ≤ 3.6 V		-0.3	VDD + 0.3 V	V
V <sub>I/O</sub> , VDD > 3.6 V		-0.3	3.9 V	V
<b>NFC antenna pin current</b>				
I <sub>NFC1/2</sub>			80	mA
<b>Radio</b>				
RF input level			10	dBm
<b>Environmental (AQFN package)</b>				
Storage temperature		-40	+125	°C
MSL	Moisture Sensitivity Level		2	
ESD HBM	Human Body Model		4	kV
ESD CDM <sub>QF</sub>	Charged Device Model		750	V
	(AQFN73, 7×7 mm package)			
<b>Flash memory</b>				
Endurance		10 000		Write/erase cycles
Retention		10 years at 40°C		



## 7. List of Holyiot module



Part No.	Nordic chip	Holyiot No.	PA	Antenna	Picture
1	nRF51822	Holyiot-17085-PA	✓	IPX antenna	 
2	nRF51822	YJ-15011-nRF51822	✗	PCB antenna	 
3	nRF51822	YJ-14015-nRF51822	✗	PCB antenna	 
4	nRF52832	YJ-16048-nRF52832	✗	PCB antenna	 
5	nRF52832	YJ-17029-nRF52832	✓	Ceramic antenna	 

6	nRF52832	YJ-16002-nRF52832	×	PCB antenna	 
7	nRF52832	YJ-17024-nRF52832	✓	IPX antenna	 
8	nRF52832	YJ-17095-nRF52832	×	Ceramic antenna	 
9	nRF52832	YJ-17017-USB	×	Ceramic antenna	 
10	nRF52832	YJ-17076-USB	×	PCB antenna	 
11	nRF52840	YJ-17120-USB	×	PCB antenna	 
12	nRF52840	YJ-18010-nRF52840	×	Ceramic antenna	 
13	nRF52840	YJ-18039-nRF52840	×	IPX antenna & PCB antenna	 