

Datasheet

产品名称 (Product): BT 5.0 module (nRF52832)

产品型号 (Model No.): Holyiot-16048 -nRF52832

目录

| | |
|---|----|
| 1. Description..... | 3 |
| Hardware module : | 3 |
| Features : | 3 |
| Application:..... | 4 |
| 2. Introduction..... | 5 |
| 2.1 Programmer..... | 5 |
| 2.2 Software development Tool..... | 5 |
| 2.3 Protocols..... | 5 |
| Software Development Kit..... | 5 |
| 2.4 SoftDevices..... | 6 |
| 3. Product Descriptions..... | 6 |
| 3.1 Mechanical drawings..... | 6 |
| 3.2 Pin assignments..... | 7 |
| 4. Mounting our board on the host PCBA..... | 9 |
| 5. Miscellaneous..... | 10 |
| 6. Absolute maximum ratings..... | 10 |
| 7. List of Holyiot module..... | 11 |

1. Description

YJ-16048 module is based on Nordic nRF52832 SoC, the nRF52832 SoC is a powerful, highly flexible ultra-low power multi-protocol SoC ideally suited for Bluetooth® low energy (previously called Bluetooth Smart), ANT and 2.4GHz ultra low-power wireless applications. The nRF52832 SoC is built around a 32-bit ARM® Cortex™-M4F CPU with 512kB + 64kB RAM. The embedded 2.4GHz transceiver supports Bluetooth low energy, ANT and proprietary 2.4 GHz protocol stack. It is on air compatible with the nRF51 Series, nRF24L and nRF24AP Series products from Nordic Semiconductor.

Processing power

Multiprotocol radio (Bluetooth low energy, ANT, 2.4G proprietary)

Power efficiency

On-chip NFC chip

Hardware module :

SWD programmer (SWDIO,SWCLK,VDD,GND)

nRF52832 QFAA

Size: 26.9mm*13mm

BLE stack & RF 2.4Ghz

Support NFC functions

Features :

Single chip, highly flexible, 2.4 GHz multi-protocol SoC

32-bit ARM Cortex-M4F Processor

1.7v to 3.6v operation

512kB flash + 64kB RAM

Supports concurrent Bluetooth low energy/ANT protocol operation

Up to +4dBm output power

-96dBm sensitivity, Bluetooth low energy

Thread safe and run-time protected

Event driven API

On air compatible with nRF24L and nRF24AP series

2 data rates (2Mbps/1Mbps)

PPI - maximum flexibility for power-efficient applications and code simplification

Automated power management system with automatic power management of each peripheral

Configurable I/O mapping for analog and digital I/O

3 x Master/Slave SPI

2 x Two-wire interface (I²C)

UART (RTS/CTS)

3 x PWM

AES HW encryption

Real Time Counter (RTC)

Digital microphone interface (PDM)

On-chip balun

Application:

- Internet of Things (IoT)
- SmartHome sensors
- Computer peripherals
- A4WP 'Rezence' wireless charging
- Sports and fitness sensors and hubs
- Smart watches
- Interactive games
- Wearables
- Connected white goods
- Voice-command smart remotes
- Beacons
- Connected health products
- RC Toys
- Building automation and sensor networks

2. Introduction

YJ-16048 module is based on Nordic nRF52832 SoC, the nRF52832 SoC is a powerful, highly flexible ultra-low power multi-protocol SoC ideally suited for Bluetooth® low energy (previously called Bluetooth Smart), ANT and 2.4GHz ultra low-power wireless applications. The nRF52832 SoC is built around a 32-bit ARM® Cortex™-M4F CPU with 512kB + 64kB RAM. The embedded 2.4GHz transceiver supports Bluetooth low energy, ANT and proprietary 2.4 GHz protocol stack. It is on air compatible with the nRF51 Series, nRF24L and nRF24AP Series products from Nordic Semiconductor.

Processing power

Multiprotocol radio (Bluetooth low energy, ANT, 2.4G proprietary)

Power efficiency

On-chip NFC chip

2.1 Programmer

Holyiot-16048 module use the Serial Wire Debug(SWD port), the module which layout the SWDIO, SWCLK, VDD, GND for debug and flash your own firmware, more info about the SWD, please visit https://www.silabs.com/community/mcu/32-bit/knowledge-base.entry.html/2014/10/21/serial_wire_debugs-qKCT

You can using the Jlink or Jtag for programmer.

2.2 Software development Tool

It supports the standard Nordic Software Development Tool-chain using Segger Embedded Studio, Keil, IAR and GCC. More info please visit <https://www.nordicsemi.com/Software-and-Tools/Development-Tools>

2.3 Protocols

This module support Bluetooth 5, Bluetooth Low Energy,Bluetooth mesh,Thread,802.15.4,ANT, 2.4GHz proprietary. So we can use different protocols for different situations.

Software Development Kit

Nordic Semiconductor's Software Development Kits (SDK) are your starting point for software

development on the nRF51 and nRF52 Series. It contains source code libraries and example applications covering wireless functions, libraries for all peripherals, bootloaders, wired and OTA FW upgrades, RTOS examples, serialization libraries.

More info please visit <https://www.nordicsemi.com/Software-and-Tools/Software/nRF5-SDK>

You can also download the SDK for coding development .

2.4 SoftDevices

Nordic Semiconductor protocol stacks are known as SoftDevices. SoftDevices are pre-compiled, pre-linked binary files. SoftDevices can be programmed in nRF5 series devices, and are freely downloadable from the Nordic website. Please download that here:

<https://www.nordicsemi.com/Software-and-Tools/Software/S132>

Over-The-Air DFU

The SoC is supported by an Over-The-Air Device Firmware Upgrade (OTA DFU) feature. This allows for in the field updates of application software and SoftDevice.

3. Product Descriptions

3.1 Mechanical drawings

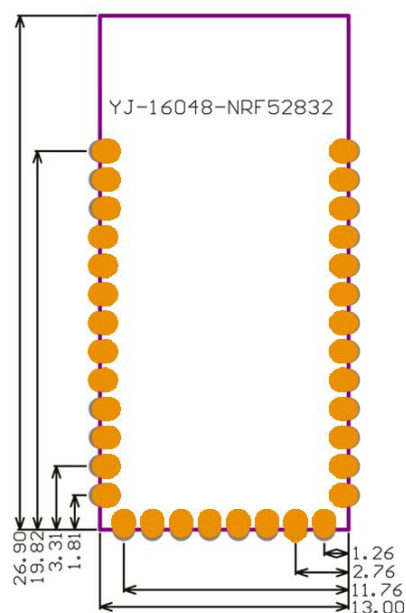

3.2 Pin assignments

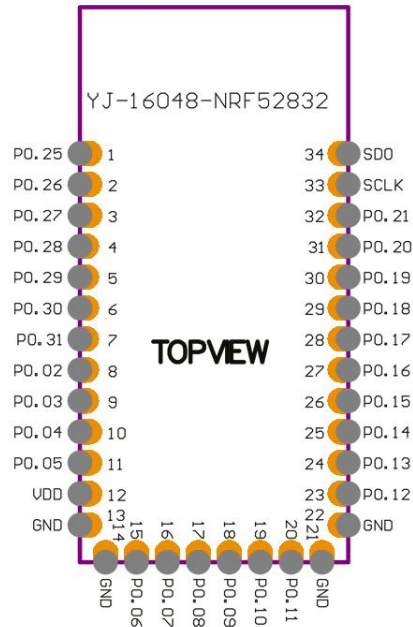

| PIN No. | PIN define | Functions |
|---------|-----------------|---|
| 1 | P0.25 | Digital I/O(general purpose I/O ²) |
| 2 | P0.26 | Digital I/O(general purpose I/O ²) |
| 3 | P0.27 | Digital I/O(general purpose I/O ²) |
| 4 | P0.28 (ANI4) | Digital I/O(general purpose I/O ² Analog input (SAADC,COMP,LPCOMP) |
| 5 | P0.29 (ANI5) | Digital I/O(general purpose I/O ² Analog input (SAADC,COMP,LPCOMP) |
| 6 | P0.30 (ANI6) | Digital I/O(general purpose I/O ² Analog input (SAADC,COMP,LPCOMP) |
| 7 | P0.31 (ANI7) | Digital I/O(general purpose I/O ² Analog input (SAADC,COMP,LPCOMP) |
| 8 | P0.02 (ANI0) | Digital I/O(general purpose I/O ² Analog input (SAADC,COMP,LPCOMP) |

| | | |
|----|-----------------------------|---|
| 9 | P0.03 (ANI1) | Digital I/O(general purpose I/O ² Analog input (SAADC,COMP,LPCOMP) |
| 10 | P0.04 (ANI2) | Digital I/O(general purpose I/O ² Analog input (SAADC,COMP,LPCOMP) |
| 11 | P0.05 (ANI3) | Digital I/O(general purpose I/O ² Analog input (SAADC,COMP,LPCOMP) |
| 12 | VDD | Power |
| 13 | GND | Ground |
| 14 | SWDIO | Digital input(serial wire debug) |
| 15 | SWCLK | Digital I/O ² (serial wire debug) |
| 16 | P0.21 (Reset) | Digital I/O(general purpose I/O ² Configure as the Pins reset |
| 17 | P0.20 Traceclk | Digital I/O(general purpose I/O Trace port clock output |
| 18 | P0.19 | Digital I/O(general purpose I/O |
| 19 | P0.18 TRACEDATA[0] / SWO | Digital I/O(general purpose I/O Single wire output, Trace port output |
| 20 | P0.17 | Digital I/O(general purpose I/O |
| 21 | P0.16 TRACEDATA[1] | Digital I/O(general purpose I/O Trace port output |
| 22 | P0.15 TRACEDATA[2] | Digital I/O(general purpose I/O Trace port output |
| 23 | P0.14 TRACEDATA[3] | Digital I/O(general purpose I/O Trace port output |
| 24 | P0.13 | Digital I/O(general purpose I/O |
| 25 | P0.12 | Digital I/O(general purpose I/O |
| 26 | GND | Ground |
| 27 | GND | Ground |
| 28 | P0.06 | Digital I/O(general purpose I/O |
| 29 | P0.07 | Digital I/O(general purpose I/O |
| 30 | P0.08 | Digital I/O(general purpose I/O |
| 31 | P0.09 NFC1 | Digital I/O(general purpose I/O ¹ NFC1 input(antenna connection) |

| | | |
|----|---------------|--|
| 32 | P0.10 NFC2 | Digital I/O(general purpose I/O ¹ NFC2 input(antenna connection) |
| 33 | P0.11 | Digital I/O(general purpose I/O |
| 34 | GND | Ground |

4. Mounting our board on the host PCBA

We suggest that you mount our RF board(Holyiot-16048-nRF52832) on the board like that:

1. For the best Bluetooth performance, the antenna of the area need to extend about several mm without ground under the antenna of the edge of the host PCB.
2. The second choice is that place our board at the corner of host PCB, the antenna of board need to extend several mm outside of the Ground plane of the host PCB.

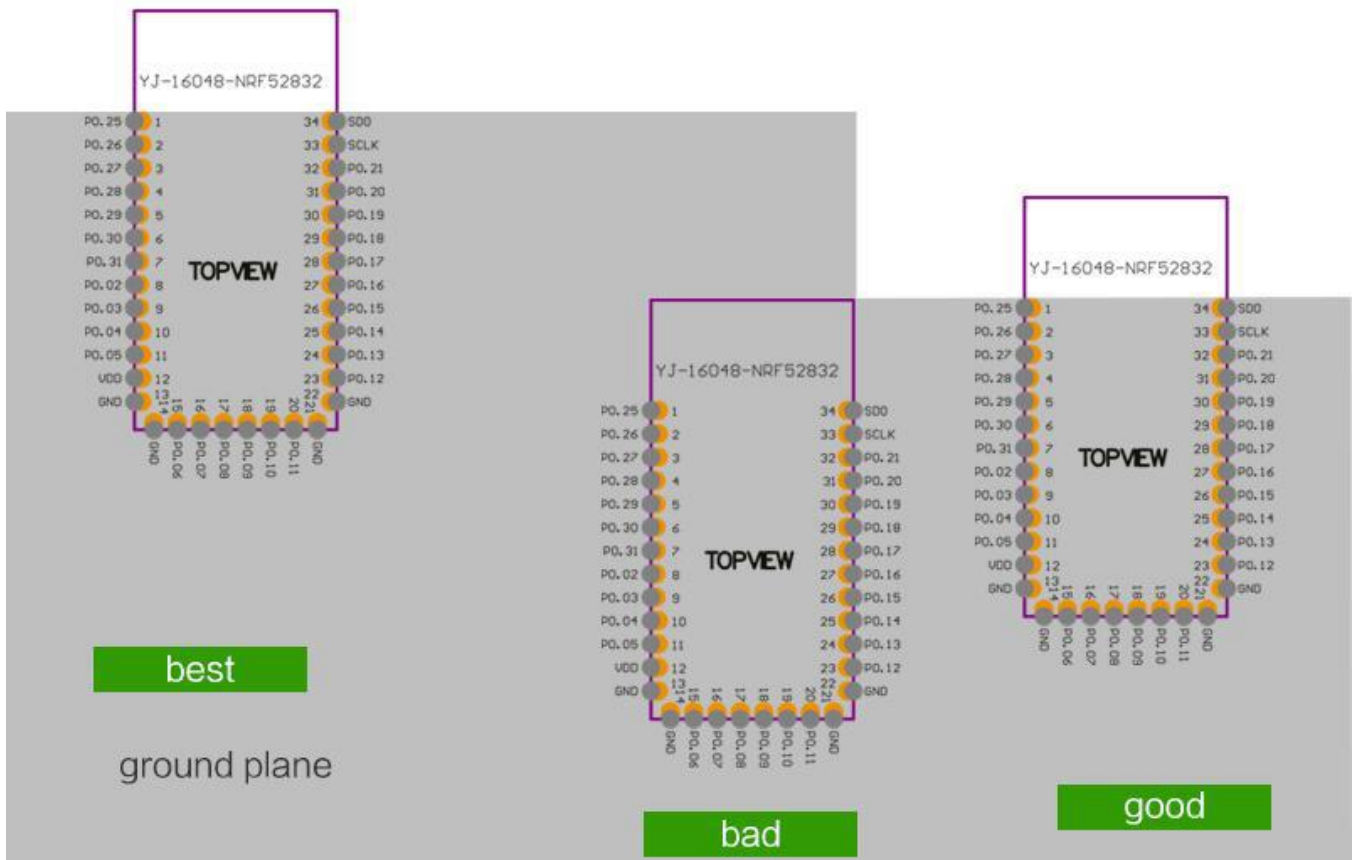
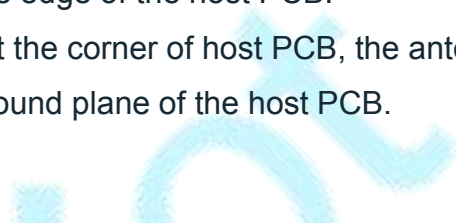

5. Miscellaneous

Soldering Temperature-Time Profile for Re-Flow Soldering. Maximum number of cycles for re-flow is 2. No opposite side re-flow is allowed due to module weight.

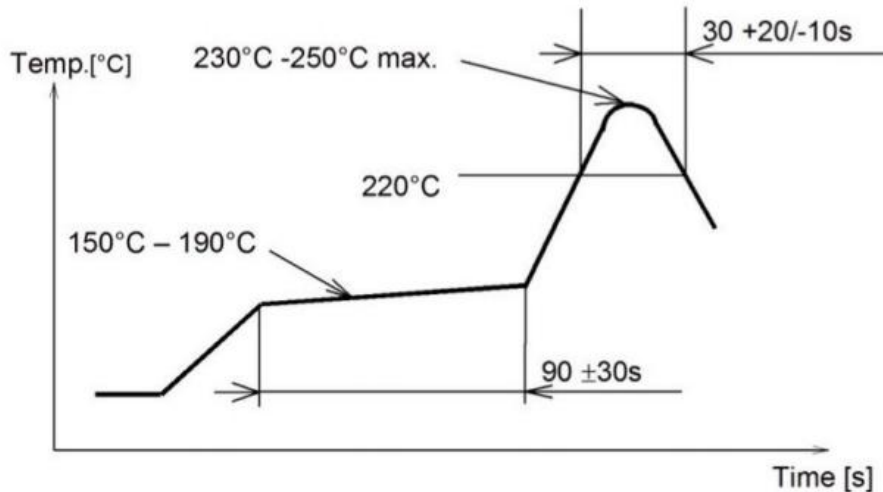

6. Absolute maximum ratings

Maximum ratings are the extreme limits to which the chip can be exposed for a limited amount of time without permanently damaging it. Exposure to absolute maximum ratings for prolonged periods of time may affect the reliability of the device.

Absolute maximum ratings:

| | Min. | Max. | Unit |
|--|------------------|-------------|--------------------|
| Supply voltages | | | |
| VDD | -0.3 | +3.9 | V |
| VSS | | 0 | V |
| I/O pin voltage | | | |
| V _{IO} , VDD ≤ 3.6 V | -0.3 | VDD + 0.3 V | V |
| V _{IO} , VDD > 3.6 V | -0.3 | 3.9 V | V |
| NFC antenna pin current | | | |
| I _{NFC1/2} | | 80 | mA |
| Radio | | | |
| RF input level | | 10 | dBm |
| Environmental QFN48, 6×6 mm package | | | |
| Storage temperature | -40 | +125 | °C |
| MSL (moisture sensitivity level) | | 2 | |
| ESD HBM (human body model) | | 4 | kV |
| ESD CDM (charged device model) | | 1000 | V |
| Environmental WLCSP, 3.0×3.2 mm package | | | |
| Storage temperature | -40 | +125 | °C |
| MSL | | 1 | |
| ESD HBM | | 2 | kV |
| ESD CDM | | 500 | V |
| Flash memory | | | |
| Endurance | 10 000 | | Write/erase cycles |
| Retention | 10 years at 40°C | | |



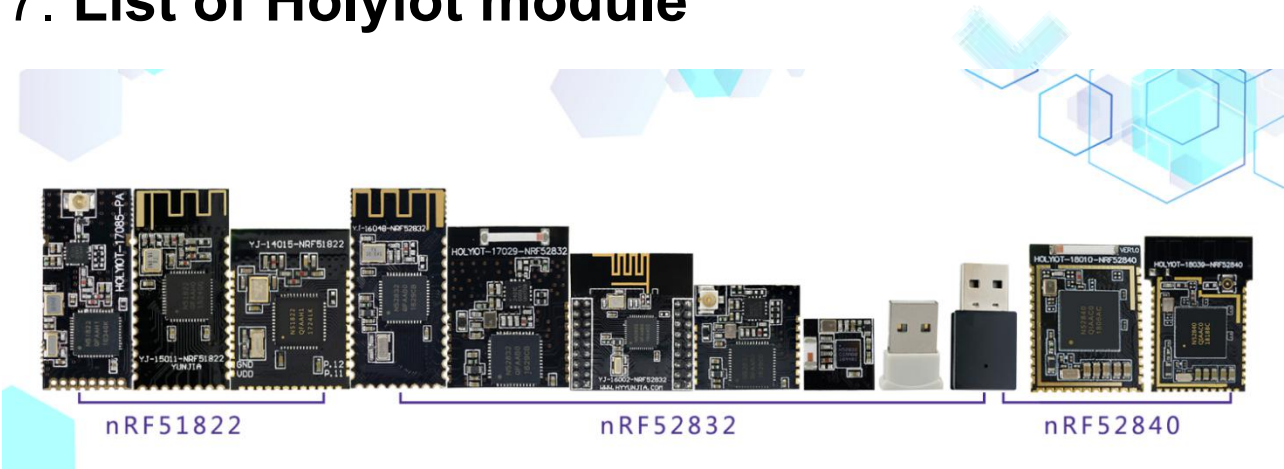

7. List of Holyiot module



| Part No. | Nordic chip | Holyiot No. | PA | Antenna | Picture |
|----------|-------------|-------------------|----|-------------|---------|
| 1 | nRF51822 | Holyiot-17085-PA | ✓ | IPX antenna | |
| 2 | nRF51822 | YJ-15011-nRF51822 | × | PCB antenna | |
| 3 | nRF51822 | YJ-14015-nRF51822 | × | PCB antenna | |

| | | | | | |
|----|----------|-------------------|---|-----------------|--|
| 4 | nRF52832 | YJ-16048-nRF52832 | × | PCB antenna |   |
| 5 | nRF52832 | YJ-17029-nRF52832 | ✓ | Ceramic antenna |   |
| 6 | nRF52832 | YJ-16002-nRF52832 | × | PCB antenna |   |
| 7 | nRF52832 | YJ-17024-nRF52832 | ✓ | IPX antenna |   |
| 8 | nRF52832 | YJ-17095-nRF52832 | × | Ceramic antenna |   |
| 9 | nRF52832 | YJ-17017-USB | × | Ceramic antenna |   |
| 10 | nRF52832 | YJ-17076-USB | × | PCB antenna |   |
| 11 | nRF52840 | YJ-17120-USB | × | PCB antenna |   |

| | | | | | |
|----|----------|-------------------|---|---------------------------|--|
| 12 | nRF52840 | YJ-18010-nRF52840 | × | Ceramic antenna |  holyiot |
| 13 | nRF52840 | YJ-18039-nRF52840 | × | IPX antenna & PCB antenna |  holyiot |

holyiot