

Datasheet

产品名称 (Product): HOLYIOT-21043-52810

产品型号 (Model No.): HOLYIOT-21043-V1.0

1. Description	3
Hardware :	3
Features :	4
Application:	6
2. Introduction	7
2.1 Programmer	7
2.2 Software development Tool	7
2.3 Protocols	7
2.4 SoftDevices	7
3. Product Descriptions	8
3.1 Mechanical drawings	8
3.2 Pin diagram	9
3.3 Pin assignment	9
4. Miscellaneous	11
5. Absolute maximum ratings	12
6. List of Holyiot module	12

1. Description

HOLYIOT-21043-V1.0 is based on Nordic nRF52810 Soc, the nRF52810 SoC is an ultra-low power 2.4 GHz wireless system on chip (SoC) integrating the nRF52 Series 2.4 GHz transceiver and an Arm® Cortex®-M4 CPU with flash memory.

nRF52810 supports *Bluetooth*® Low Energy, the ANT™ protocol, and a range of proprietary 2.4 GHz protocols, such as Gazell from Nordic Semiconductor. Fully qualified Bluetooth Low Energy stacks for nRF52810 are implemented in the S100 series of SoftDevices. The S100 series of SoftDevices are available for free and can be downloaded and installed on nRF52810 independent of your own application code.

nRF52810 is part of the nRF52 product family that offers you code compatible devices across the nRF52 Series and simple software migration from the nRF51 family.

Hardware :

SWD programmer (SWDIO,SWCLK,VDD,GND)

nRF52810 QFAA

Size :22.6mm*15.0mm

BLE stack & RF 2.4Ghz

Features :

- 2.4 GHz transceiver
 - -96 dBm sensitivity in Bluetooth low energy mode
 - Supported data rates: 1 Mbps, 2 Mbps Bluetooth low energy mode
 - -20 to +4 dBm TX power, configurable in 4 dB steps
 - On-chip balun (single-ended RF)
 - 4.6 mA peak current in TX (0 dBm)
 - 4.6 mA peak current in RX
 - RSSI (1 dB resolution)
- ARM® Cortex®-M4 32-bit processor, 64 MHz
 - 144 EEMBC CoreMark® score running from flash memory
 - 34.4 μ A/MHz running CoreMark from flash memory
 - 32.8 μ A/MHz running CoreMark from RAM memory
 - Serial wire debug (SWD)
- Flexible power management
 - 1.7 V to 3.6 V supply voltage range
 - Fully automatic LDO and DC/DC regulator system
 - Fast wake-up using 64 MHz internal oscillator
 - 0.3 μ A at 3 V in System OFF mode, no RAM retention
 - 0.5 μ A at 3 V in System OFF mode with full 24 kB RAM retention
 - 1.5 μ A at 3 V in System ON mode, with full 24 kB RAM retention, wake on RTC
 - 1.4 μ A at 3 V in System ON mode, no RAM retention, wake on RTC
- 192 kB flash and 24 kB RAM
- Nordic SoftDevice ready
- Support for concurrent multi-protocol

- 12-bit, 200 ksps ADC - 8 configurable channels with programmable gain
- 64 level comparator
- Temperature sensor
- Up to 32 general purpose I/O pins
- 4-channel pulse width modulator (PWM) unit with EasyDMA
- Digital microphone interface (PDM)
- 3x 32-bit timer with counter mode
- SPI master/slave with EasyDMA
- I2C compatible 2-wire master/slave
- UART (CTS/RTS) with EasyDMA
- Programmable peripheral interconnect (PPI)
- Quadrature decoder (QDEC)
- AES HW encryption with EasyDMA
- 2x real-time counter (RTC)
- Single crystal operation
- Package variants
 - QFN48 package, 6 x 6 mm
 - QFN32 package, 5 x 5 mm
 - WLCSP package, 2.482 x 2.464 mm

Application:

- Computer peripherals and I/O devices
 - Mouse
 - Keyboard
 - Mobile HID
- CE remote controls
- Network processor
 - Wearables
 - Virtual reality headsets
- Health and medical
- Enterprise lighting
 - Industrial
 - Commercial
 - Retail
- Beacons
- Connectivity device in multi-chip solutions

2. Introduction

2.1 Programmer

HOLYIOT-21043-V1.0 use the Serial Wire Debug(SWD port), the module which layout the SWDIO, SWCLK, VDD, GND for debug and flash your own firmware, more info about the SWD, please visit https://www.silabs.com/community/mcu/32-bit/knowledge-base.entry.html/2014/10/21/serial_wire_debugs-qKCT

You can using the Jlink or Jtag for programmer.

2.2 Software development Tool

It supports the standard Nordic Software Development Tool-chain using Segger Embedded Studio, Keil, IAR and GCC. More info please visit <https://www.nordicsemi.com/Software-and-Tools/Development-Tools>

2.3 Protocols

This product support Bluetooth 5, Bluetooth Low Energy,Bluetooth mesh,Thread,802.15.4,ANT, 2.4GHz proprietary. So we can use different protocols for different situations.

Software Development Kit

Nordic Semiconductor's Software Development Kits (SDK) are your starting point for software development on the nRF51 and nRF52 Series. It contains source code libraries and example applications covering wireless functions, libraries for all peripherals, bootloaders, wired and OTA FW upgrades, RTOS examples, serialization libraries.

More info please visit <https://www.nordicsemi.com/Software-and-Tools/Software/nRF5-SDK>

You can also download the SDK for coding development .

2.4 SoftDevices

Nordic Semiconductor protocol stacks are known as SoftDevices. SoftDevices are pre-compiled, pre-linked binary files. SoftDevices can be programmed in nRF5 series devices, and are freely downloadable from the Nordic website. Please download that here:

<https://www.nordicsemi.com/Software-and-Tools/Software/S112>

Over-The-Air DFU

The SoC is supported by an Over-The-Air Device Firmware Upgrade (OTA DFU) feature. This allows for in the field updates of application software and SoftDevice.

3. Product Descriptions

3.1 Mechanical drawings

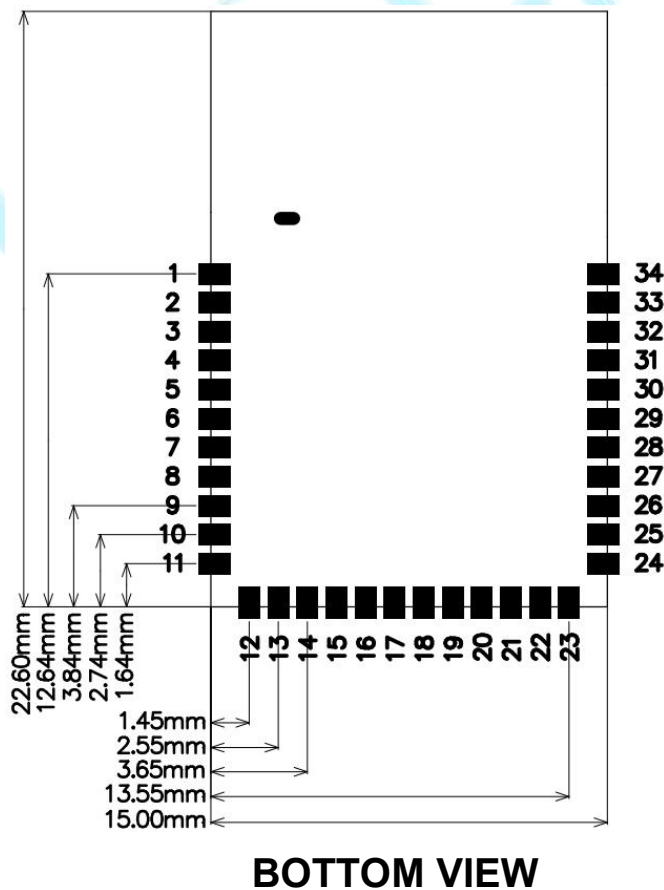
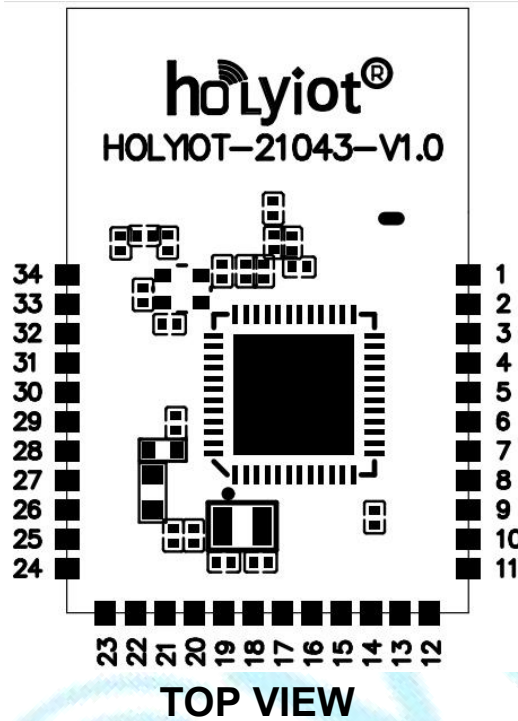

3.2 Pin diagram

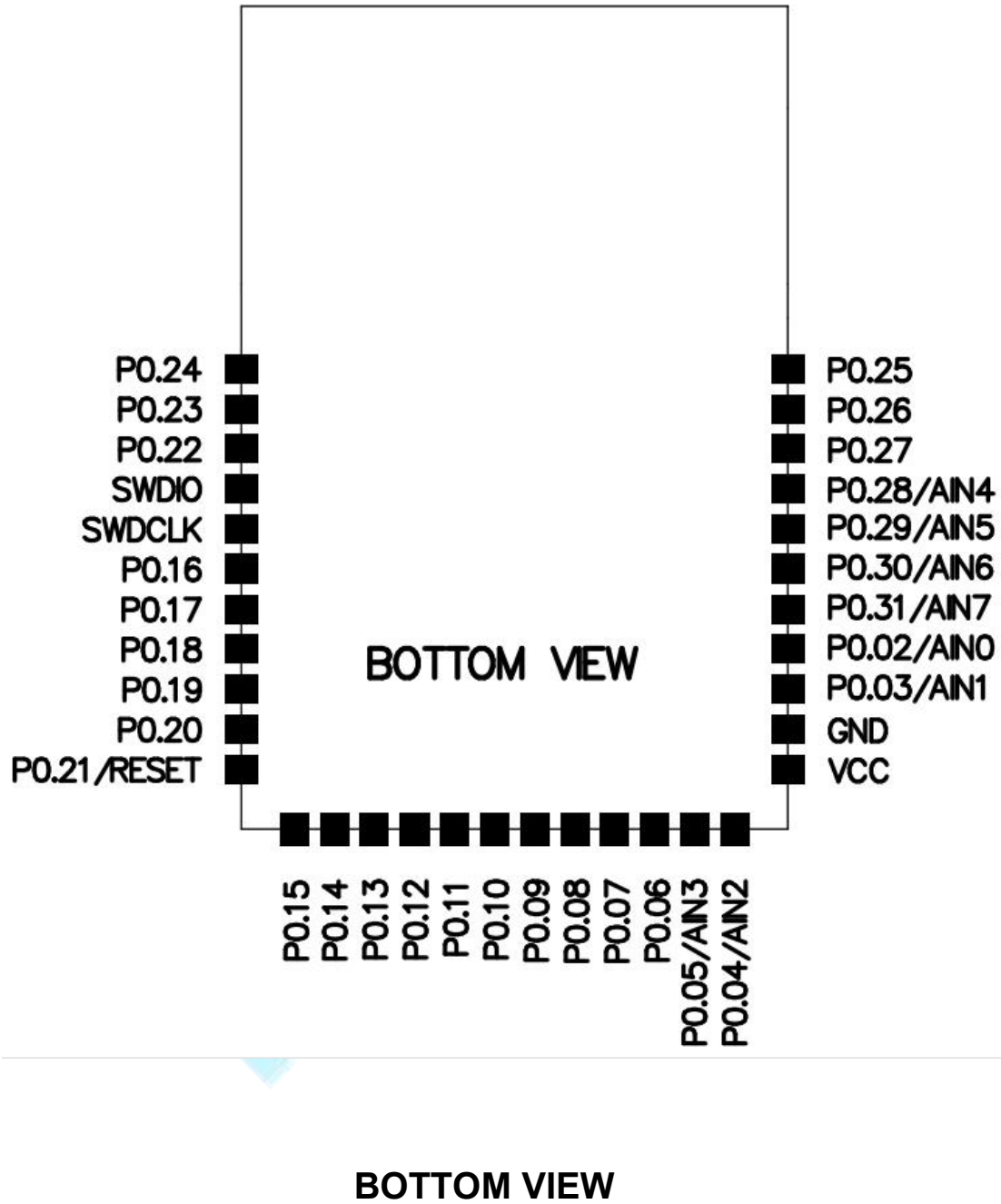

3.3 Pin assignment

PIN No.	PIN define	Functions
1	P0.24	General purpose I/O
2	P0.23	General purpose I/O
3	P0.22	General purpose I/O
4	SWDIO	Serial wire debug I/O for debug and programming
5	SWDCLK	Serial wire debug clock input for debug and programming
6	P0.16	General purpose I/O
7	P0.17	General purpose I/O
8	P0.18	General purpose I/O
9	P0.19	General purpose I/O
10	P0.20	General purpose I/O
11	P0.21/RESET	General purpose I/O Configurable as pin reset
12	P0.15	General purpose I/O
13	P0.14	General purpose I/O
14	P0.13	General purpose I/O
15	P0.12	General purpose I/O
16	P0.11	General purpose I/O
17	P0.10	General purpose I/O
18	P0.09	General purpose I/O
19	P0.08	General purpose I/O
20	P0.07	General purpose I/O
21	P0.06	General purpose I/O
22	P0.05 AIN3	General purpose I/O COMP input SAADC input
23	P0.04 AIN2	General purpose I/O COMP input SAADC input
24	VCC	Power supply
25	GND	Ground
26	P0.03 AIN1	General purpose I/O COMP input SAADC input

PIN No.	PIN define	Functions
27	P0.02 AIN0	General purpose I/O COMP input SAADC input
28	P0.31 AIN7	General purpose I/O COMP input SAADC input
29	P0.30 AIN6	NO connect Leave unconnected
30	P0.29 AIN5	General purpose I/O COMP input SAADC input
31	P0.28 AIN4	General purpose I/O COMP input SAADC input
32	P0.27	General purpose I/O
33	P0.26	General purpose I/O
34	P0.25	General purpose I/O

4. Miscellaneous

Soldering Temperature-Time Profile for Re-Flow Soldering. Maximum number of cycles for re-flow is 2. No opposite side re-flow is allowed due to module weight.

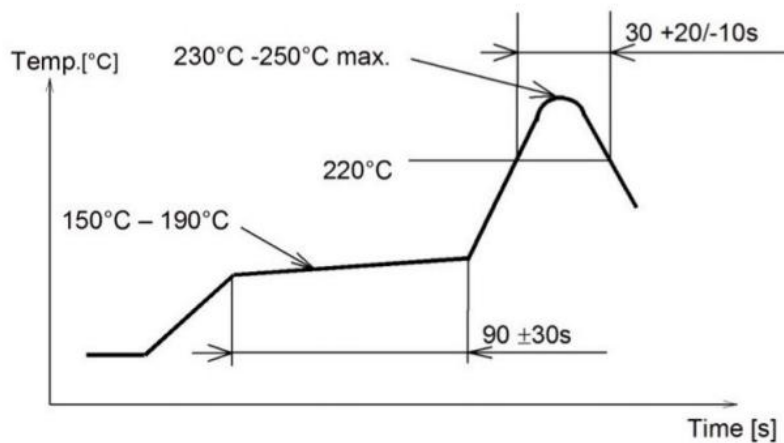





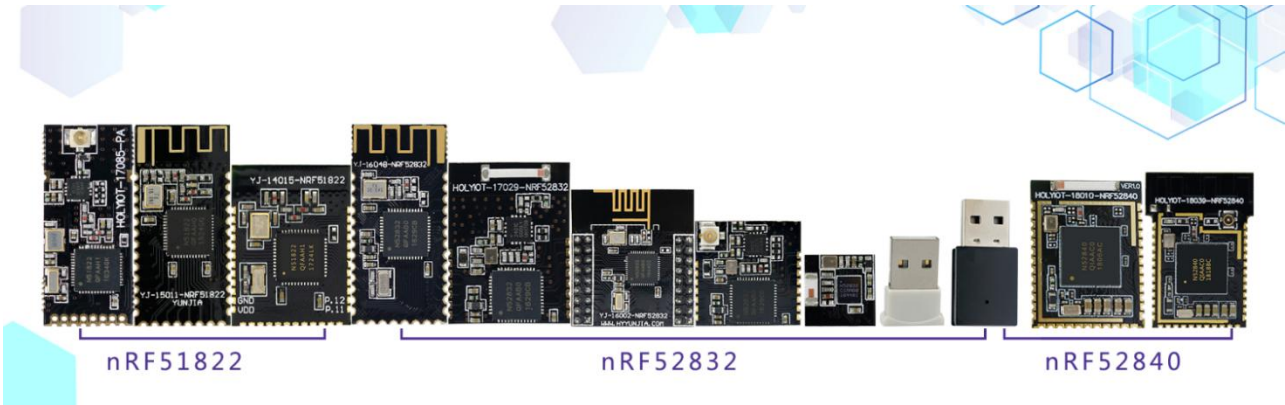

5. Absolute maximum ratings

Maximum ratings are the extreme limits to which the chip can be exposed for a limited amount of time without permanently damaging it. Exposure to absolute maximum ratings for prolonged periods of time may affect the reliability of the device.

	Note	Min.	Max.	Unit
Supply voltages				
VDD		-0.3	+3.9	V
VSS			0	V
I/O pin voltage				
$V_{I/O}$, VDD ≤ 3.6 V		-0.3	VDD + 0.3	V
$V_{I/O}$, VDD > 3.6 V		-0.3	3.9	V
Radio				
RF input level			10	dBm
Environmental QFN package				
Storage temperature		-40	+125	°C
MSL	Moisture Sensitivity Level		2	
ESD HBM	Human Body Model		4	kV
ESD HBM Class	Human Body Model Class		3A	
ESD CDM	Charged Device Model		1	kV
Environmental WLCSP 2.482 x 2.464 mm package				
Storage temperature		-40	+125	°C
MSL	Moisture Sensitivity Level		1	
ESD HBM	Human Body Model		2	kV
ESD HBM Class	Human Body Model Class		2	
ESD CDM	Charged Device Model		1	kV
Flash memory				
Endurance		10 000		Write/erase cycles
Retention		10 years at 40°C		





Part No.	Nordic chip	Holyiot No.	PA	Antenna	Picture
1	nRF51822	Holyiot-17085-PA	✓	IPX antenna	
2	nRF51822	YJ-15011-nRF51822	✗	PCB antenna	
3	nRF51822	YJ-14015-nRF51822	✗	PCB antenna	
4	nRF52832	YJ-16048-nRF52832	✗	PCB antenna	
5	nRF52832	YJ-17029-nRF52832	✓	Ceramic antenna	

6	nRF52832	YJ-16002-nRF52832	×	PCB antenna	 
7	nRF52832	YJ-17024-nRF52832	✓	IPX antenna	 
8	nRF52832	YJ-17095-nRF52832	×	Ceramic antenna	 
9	nRF52832	YJ-17017-USB	×	Ceramic antenna	 
10	nRF52832	YJ-17076-USB	×	PCB antenna	 
11	nRF52840	YJ-17120-USB	×	PCB antenna	 
12	nRF52840	YJ-18010-nRF52840	×	Ceramic antenna	 
13	nRF52840	YJ-18039-nRF52840	×	IPX antenna & PCB antenna	 

14	nRF52840	HOLYIOT-19059- nRF52840	√	IPX antenna & PCB antenna	
----	----------	----------------------------	---	------------------------------	--

