

# Datasheet

产品名称 (Product): BLE module (nRF51822)

产品型号 (Model No.): YJ-14015-nRF51822

目录

|                                    |    |
|------------------------------------|----|
| 1. Description.....                | 3  |
| 2. Introduction.....               | 4  |
| 2.1 Programmer.....                | 5  |
| 2.2 Software development Tool..... | 5  |
| 2.3 Protocols.....                 | 5  |
| Software Development Kit.....      | 5  |
| 2.4 SoftDevices.....               | 5  |
| 3. Product Descriptions.....       | 6  |
| 3.1 Mechanical drawings.....       | 6  |
| 3.2 Pin assignments.....           | 7  |
| 4. Miscellaneous.....              | 8  |
| 5. Absolute maximum ratings.....   | 9  |
| 6. List of Holyiot module.....     | 10 |

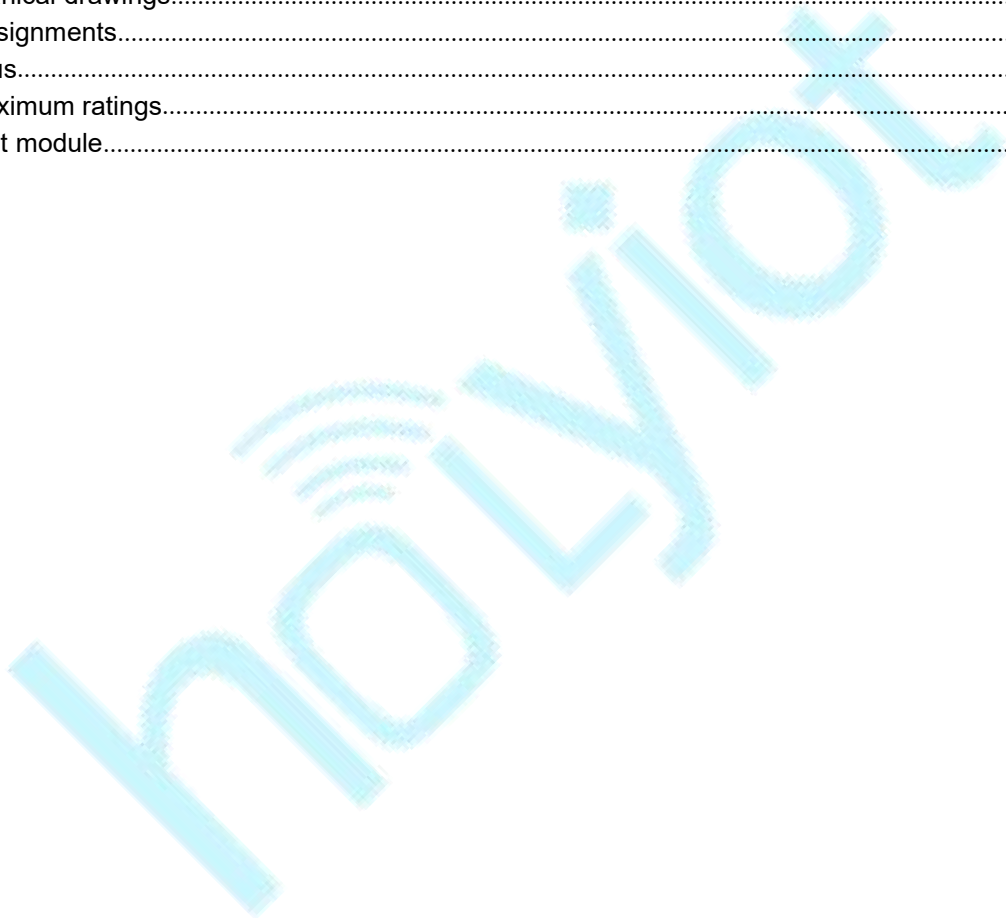

# 1. Description

YJ-14015 BLE module use nRF51822 QFAA chip, it can broadcast data. YJ-14015-nRF51822 module is a powerful, highly flexible multiprotocol SoC ideally suited for Bluetooth® low energy and 2.4GHz ultra low-power wireless applications. The nRF51822 is built around a 32-bit ARM® Cortex™ M0 CPU with 256kB flash + 16kB RAM for improved application performance. The embedded 2.4GHz transceiver supports both Bluetooth low energy and the Nordic Gazell 2.4 GHz protocol stack which is on air compatible with the nRF24L series products from Nordic Semiconductor.

PCB antenna

Size : 19.80mm(L) \*15.00mm(W)

NRF51822 QFAA

## Features :

Single chip, highly flexible, 2.4 GHz multi-protocol device

32-bit ARM Cortex M0 CPU core

256kB flash + 16kB RAM

Supports Bluetooth low energy protocol stacks

Thread safe and run-time protected

Event driven API

On air compatible with nRF24L series

3 data rates (2Mbps/1Mbps/250kbps)

+4dBm output power

-93dBm sensitivity, Bluetooth low energy

PPI system for maximum power-efficient applications and code simplification

Flexible power management system with automatic power management of each peripheral

Configurable I/O mapping for analog and digital I/O

Operating temperature range: -40°C to +105°C

## Application:

- Mobile phone accessories
- Wearables
- Beacons
- Rezence wireless charging monitoring
- PC peripherals
- Consumer Electronics (CE) remote controls
- Proximity/Alert sensors
- Smart Home
- Sports, fitness and healthcare sensors
- Smart RF tags
- Toys and electronic games
- Intelligent domestic appliances
- Industrial and commercial sensors
- Lighting

## 2. Introduction

YJ-14015 BLE module use nRF51822 QFAA chip, it can broadcast data. YJ-14015-nRF51822 module is a powerful, highly flexible multiprotocol SoC ideally suited for Bluetooth® low energy and 2.4GHz ultra low-power wireless applications. The nRF51822 is built around a 32-bit ARM® Cortex™ M0 CPU with 256kB flash + 16kB RAM for improved application performance. The embedded 2.4GHz transceiver supports both Bluetooth low energy and the Nordic Gazell 2.4 GHz protocol stack which is on air compatible with the nRF24L series products from Nordic Semiconductor.

PCB antenna

Size : 19.80mm(L) \*15.00mm(W)

NRF51822 QFAA

## 2.1 Programmer

YJ-14015 BLE module use the Serial Wire Debug(SWD port ), the module which layout the SWDIO, SWCLK, VDD, GND for debug and flash your own firmware, more info about the SWD, please visit [https://www.silabs.com/community/mcu/32-bit/knowledge-base.entry.html/2014/10/21/serial\\_wire\\_debugs-qKCT](https://www.silabs.com/community/mcu/32-bit/knowledge-base.entry.html/2014/10/21/serial_wire_debugs-qKCT)

You can using the Jlink or Jtag for programmer.

## 2.2 Software development Tool

It supports the standard Nordic Software Development Tool-chain using Segger Embedded Studio, Keil, IAR and GCC. More info please visit

[https://www.nordicsemi.com/DocLib/Content/User\\_Guides/getting\\_started/latest/UG/common/nordic\\_tools](https://www.nordicsemi.com/DocLib/Content/User_Guides/getting_started/latest/UG/common/nordic_tools)

## 2.3 Protocols

### Software Development Kit

Nordic Semiconductor's Software Development Kits (SDK) are your starting point for software development on the nRF51 and nRF52 Series. It contains source code libraries and example applications covering wireless functions, libraries for all peripherals, bootloaders, wired and OTA FW upgrades, RTOS examples, serialization libraries.

More info please visit

[https://www.nordicsemi.com/DocLib/Content/User\\_Guides/getting\\_started/latest/UG/gs/development\\_sw](https://www.nordicsemi.com/DocLib/Content/User_Guides/getting_started/latest/UG/gs/development_sw)

You can also download the SDK for coding development .

## 2.4 SoftDevices

Nordic Semiconductor protocol stacks are known as SoftDevices. SoftDevices are pre-compiled, pre-linked binary files. SoftDevices can be programmed in nRF5 series devices, and are freely downloadable from the Nordic website.

Please download that here: <https://www.nordicsemi.com/Software-and-Tools/Software/S130>

## Over-The-Air DFU

The SoC is supported by an Over-The-Air Device Firmware Upgrade (OTA DFU) feature. This allows for in the field updates of application software and SoftDevice.

# 3. Product Descriptions

## 3.1 Mechanical drawings

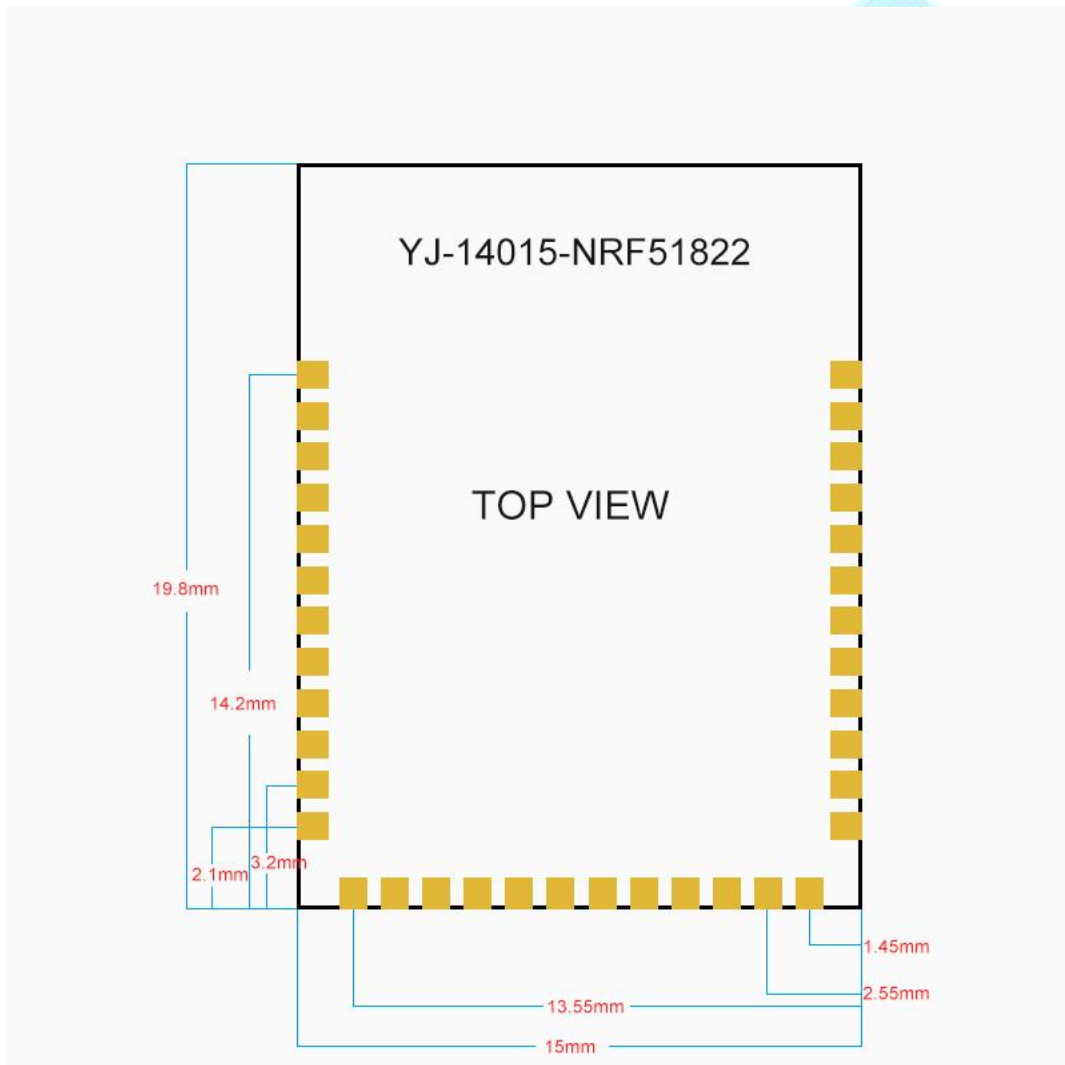

### 3.2 Pin assignments

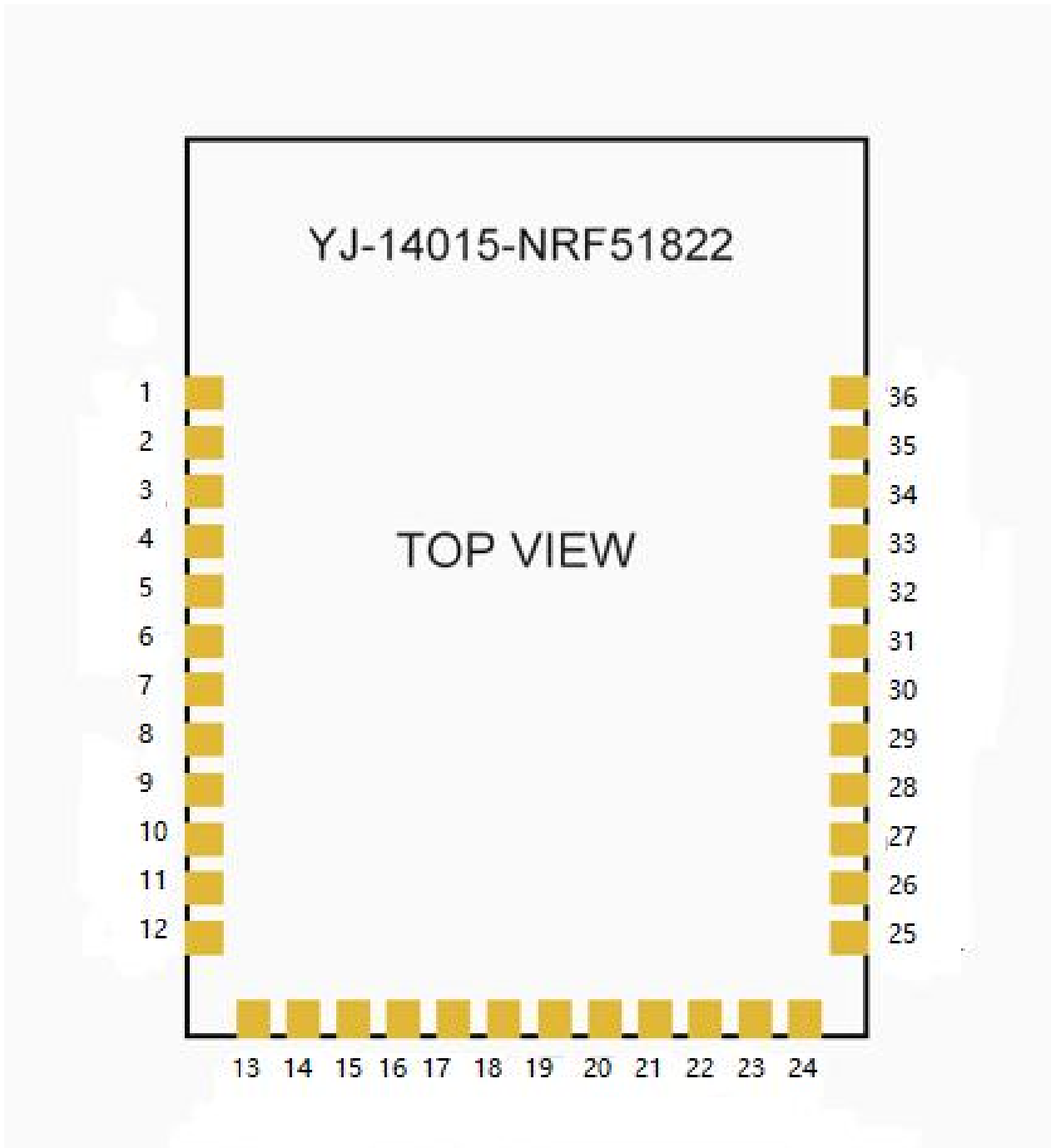

| PIN No. | PIN define | Functions   |
|---------|------------|-------------|
| 1       | GND        | Ground      |
| 2       | P0.21      | Digital I/O |
| 3       | P0.22      | Digital I/O |
| 4       | P0.23      | Digital I/O |
| 5       | P0.24      | Digital I/O |

|    |       |  |
|----|-------|--|
| 6  | P0.25 | Digital I/O  |
| 7  | NC    |  |
| 8  | NC    |  |
| 9  | P0.28 | Digital I/O Analog input   |
| 10 | P0.29 | Digital I/O Analog input   |
| 11 | GND   | Ground   |
| 12 | VDD   | Power  |
| 13 | P0.30 | Digital I/O Analog input   |
| 14 | P0.00 | Digital I/O Analog input   |
| 15 | P0.01 | Digital I/O Analog input   |
| 16 | P0.02 | Digital I/O Analog input   |
| 17 | P0.03 | Digital I/O Analog input   |
| 18 | P0.04 | Digital I/O Analog input   |
| 19 | P0.05 | Digital I/O<br>Analog input (SAADC,COMP,LPCOMP)                      |
| 20 | P0.06 | Digital I/O  |
| 21 | P0.07 | Digital I/O Trace clock  |
| 22 | P0.08 | Digital I/O  |
| 23 | P0.09 | Digital I/O  |
| 24 | P0.10 | Digital I/O  |
| 25 | P0.11 | Digital I/O  |
| 26 | P0.12 | Digital I/O  |
| 27 | P0.13 | Digital I/O  |
| 28 | P0.14 | Digital I/O  |
| 29 | P0.15 | Digital I/O  |
| 30 | P0.16 | Digital I/O  |
| 31 | SWDIO | System reset (active low). Hardware debug and flash programming I/O. |
| 32 | SWCLK | Hardware debug and flash programming I/O.                            |
| 33 | P0.17 | Digital I/O  |
| 34 | P0.18 | Digital I/O  |
| 35 | P0.19 | Digital I/O  |
| 36 | P0.20 | Digital I/O  |



## 4. Miscellaneous

Soldering Temperature-Time Profile for Re-Flow Soldering. Maximum number of cycles for re-flow is 2. No opposite side re-flow is allowed due to module weight.

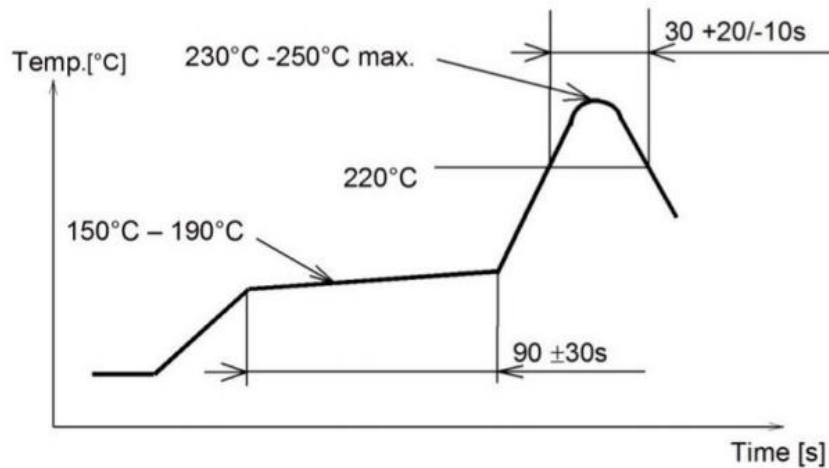

## 5. Absolute maximum ratings

Maximum ratings are the extreme limits to which the chip can be exposed for a limited amount of time without permanently damaging it. Exposure to absolute maximum ratings for prolonged periods of time may affect the reliability of the device.

Absolute maximum ratings:











| Symbol   | Parameter                  | Min.                                   | Max.      | Unit               |
|--|----------------------------|--|-----------|--------------------|
| <b>Supply voltages</b>   |                            |  |           |                    |
| VDD  |                            | -0.3                                   | +3.9      | V                  |
| DEC2   |                            |  | 2         | V                  |
| VSS  |                            |  | 0         | V                  |
| <b>I/O pin voltage</b>   |                            |  |           |                    |
| VIO  |                            | -0.3                                   | VDD + 0.3 | V                  |
| <b>Environmental QFN48 package</b>                             |                            |  |           |                    |
| Storage temperature  |                            | -40                                    | +125      | °C                 |
| MSL  | Moisture Sensitivity Level |  | 2         |                    |
| ESD HBM  | Human Body Model           |  | 4         | kV                 |
| ESD CDM  | Charged Device Model       |  | 750       | V                  |
| <b>Environmental WLCSP package</b>                             |                            |  |           |                    |
| Storage temperature  |                            | -40                                    | +125      | °C                 |
| MSL  | Moisture Sensitivity Level |  | 1         |                    |
| ESD HBM  | Human Body Model           |  | 4         | kV                 |
| ESD CDM  | Charged Device Model       |  | 500       | V                  |
| <b>Flash memory</b>  |                            |  |           |                    |
| Endurance  |                            | 20 000 <sup>1</sup>                    |           | write/erase cycles |
| Retention  |                            | 10 years at 40 °C<br>50 years at 25 °C |           |                    |
| Number of times an address can be written between erase cycles |                            |  | 2         | times              |

1. Flash endurance is 20,000 erase cycles. The smallest element of flash that can be written is a 32 bit word.



## 6. List of Holyiot module



| Part No. | Nordic chip | Holyiot No.       | PA | Antenna         | Picture  |
|----------|-------------|-------------------|----|-----------------|--|
| 1        | nRF51822    | Holyiot-17085-PA  | ✓  | IPX antenna     | <br>     |
| 2        | nRF51822    | YJ-15011-nRF51822 | ×  | PCB antenna     | <br> |
| 3        | nRF51822    | YJ-14015-nRF51822 | ×  | PCB antenna     | <br> |
| 4        | nRF52832    | YJ-16048-nRF52832 | ×  | PCB antenna     | <br> |
| 5        | nRF52832    | YJ-17029-nRF52832 | ✓  | Ceramic antenna | <br> |

|    |          |                   |   |                           |  |
|----|----------|-------------------|---|---------------------------|--|
| 6  | nRF52832 | YJ-16002-nRF52832 | × | PCB antenna               | <br>     |
| 7  | nRF52832 | YJ-17024-nRF52832 | ✓ | IPX antenna               | <br>     |
| 8  | nRF52832 | YJ-17095-nRF52832 | × | Ceramic antenna           | <br>     |
| 9  | nRF52832 | YJ-17017-USB      | × | Ceramic antenna           | <br>    |
| 10 | nRF52832 | YJ-17076-USB      | × | PCB antenna               | <br> |
| 11 | nRF52840 | YJ-17120-USB      | × | PCB antenna               | <br> |
| 12 | nRF52840 | YJ-18010-nRF52840 | × | Ceramic antenna           | <br> |
| 13 | nRF52840 | YJ-18039-nRF52840 | × | IPX antenna & PCB antenna | <br> |